

## Application

The EFY-445 extruded aluminum louver is designed for intake and exhaust application where line-of-sight protection is critical. The EFY-445 is well suited for special shape applications and is available with hidden mullions for a continuous blade appearance. The EFY-445 is available in a wide array of anodized and painted finishes including custom color matching.

## Standard Construction

- Material:** Mill finish 6063-T5 extruded aluminum.
- Frame:** 4" deep × 0.081" thick (102 × 2) channel.
- Blades:** 45° × 0.081" (2) thick inverted "Y" style.
- Screen:** 1/2" × 0.063" (12.7 × 1.6) expanded and flattened aluminum.
- Mullion:** Visible.
- Screen Frame:** Removable.
- Minimum Size:** 4.5" × 7" (114 × 178)
- Maximum Size:** Single section: 60" × 120" (1524 × 3048)  
 120" × 60" (3048 × 1524)  
 Multiple section: Unlimited

## Options

- Factory finish:
  - High Performance Fluoropolymer - 100% resin Newlar®/ 70% resin Kynar®
  - Baked Enamel
  - Clear or Color Anodized, Class 1
  - Prime Coat
- Hidden vertical mullion for continuous blade appearance.
- 1 1/2" (38) flange frame.
- Welded construction.
- Alternate bird or insect screens.
- Alternate removable one-piece U-channel screen frame.
- Insulated or non-insulated blank-off panels.
- Filter racks.
- Hinged frame.
- Head and/or sill flashing.

## Ratings

**Free Area:** [48" × 48" (1219 × 1219) unit]: 6.2 ft<sup>2</sup> (0.58 m<sup>2</sup>)  
 38.8%

### Performance @ Beginning Point of Water Penetration

**Free Area Velocity:** 745 fpm (3.78 m/s)  
**Air Volume Delivered:** 4,589 cfm (2.17 m<sup>3</sup>/s)  
**Pressure Loss:** 0.18 in.wg. (45 Pa)

**Velocity @ 0.15 in.wg. Pressure Loss:** 650 fpm (3.30 m/s)

**Design Load:** 30 psf

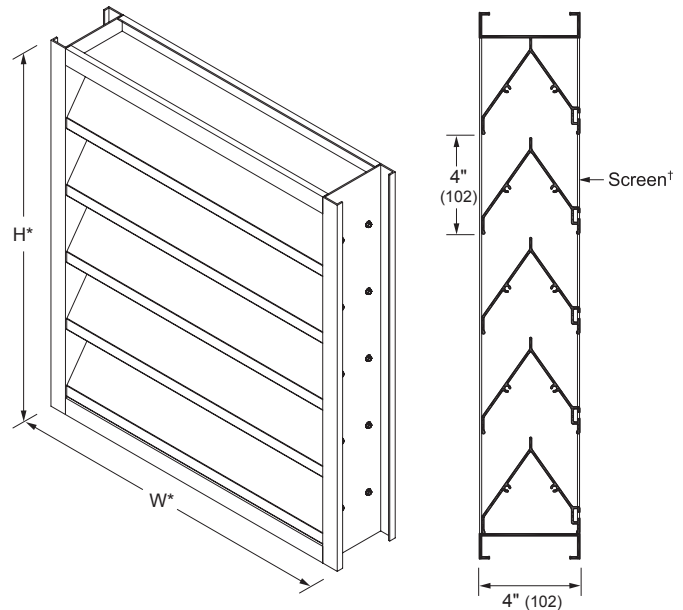

Model **EFY-445**  
 (standard)

\*Louver dimensions furnished approximately 1/2" (13) undersize.

**Vertical Section**

†Screen adds approximately 3/16" (5) to louver depth.

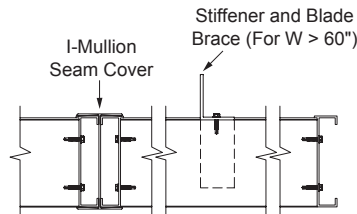

**Visible Vertical Mullion**  
 (standard)

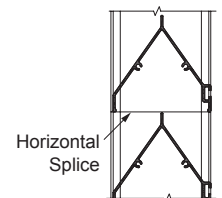

**Horizontal Mullion**  
 (standard)

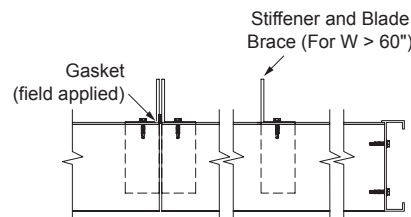

**Hidden Vertical Mullion**  
 (optional)

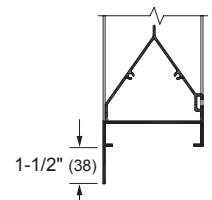

**Flange Frame**  
 (optional)

# Performance Data

## Free Area (ft<sup>2</sup>)

		Width (Inches)																		
		12	18	24	30	36	42	48	54	60	66	72	78	84	90	96	102	108	114	120
Height (Inches)	12	0.2	0.3	0.5	0.6	0.7	0.8	1.0	1.1	1.2	1.3	1.5	1.6	1.7	1.8	1.9	2.1	2.2	2.3	2.4
	18	0.4	0.6	0.9	1.1	1.4	1.6	1.8	2.1	2.3	2.5	2.8	3.0	3.3	3.5	3.7	4.0	4.2	4.4	4.7
	24	0.6	0.9	1.3	1.6	2.0	2.3	2.7	3.1	3.4	3.8	4.1	4.5	4.8	5.2	5.5	5.9	6.2	6.6	6.9
	30	0.8	1.2	1.7	2.2	2.6	3.1	3.6	4.0	4.5	5.0	5.4	5.9	6.4	6.8	7.3	7.7	8.2	8.7	9.1
	36	1.0	1.5	2.1	2.7	3.3	3.9	4.4	5.0	5.6	6.2	6.7	7.3	7.9	8.5	9.1	9.6	10.2	10.8	11.4
	42	1.2	1.8	2.5	3.2	3.9	4.6	5.3	6.0	6.7	7.4	8.1	8.8	9.4	10.1	10.8	11.5	12.2	12.9	13.6
	48	1.3	2.1	3.0	3.8	4.6	5.4	6.2	7.0	7.8	8.6	9.4	10.2	11.0	11.8	12.6	13.4	14.2	15.0	15.8
	54	1.5	2.4	3.4	4.3	5.2	6.1	7.0	7.9	8.9	9.8	10.7	11.6	12.5	13.4	14.4	15.3	16.2	17.1	18.0
	60	1.7	2.8	3.8	4.8	5.8	6.9	7.9	8.9	10.0	11.0	12.0	13.0	14.1	15.1	16.1	17.2	18.2	19.2	20.3
	66	1.9	3.1	4.2	5.3	6.5	7.6	8.8	9.9	11.1	12.2	13.3	14.5	15.6	16.8	17.9	19.0	20.2	21.3	22.5
	72	2.1	3.4	4.6	5.9	7.1	8.4	9.6	10.9	12.1	13.4	14.7	15.9	17.2	18.4	19.7	20.9	22.2	23.4	24.7
	78	2.3	3.7	5.0	6.4	7.8	9.1	10.5	11.9	13.2	14.6	16.0	17.3	18.7	20.1	21.4	22.8	24.2	25.6	26.9
	84	2.5	4.0	5.4	6.9	8.4	9.9	11.4	12.8	14.3	15.8	17.3	18.8	20.3	21.7	23.2	24.7	26.2	27.7	29.1
	90	2.7	4.3	5.9	7.4	9.0	10.6	12.2	13.8	15.4	17.0	18.6	20.2	21.8	23.4	25.0	26.6	28.2	29.8	31.4
	96	2.9	4.6	6.3	8.0	9.7	11.4	13.1	14.8	16.5	18.2	19.9	21.6	23.3	25.0	26.8	28.5	30.2	31.9	33.6
	102	3.0	4.9	6.7	8.5	10.3	12.1	14.0	15.8	17.6	19.4	21.2	23.1	24.9	26.7	28.5	30.3	32.2	34.0	35.8
108	3.2	5.2	7.1	9.0	11.0	12.9	14.8	16.8	18.7	20.6	22.6	24.5	26.4	28.4	30.3	32.2	34.2	36.1	38.0	
114	3.4	5.5	7.5	9.6	11.6	13.6	15.7	17.7	19.8	21.8	23.9	25.9	28.0	30.0	32.1	34.1	36.2	38.2	40.3	
120	3.6	5.8	7.9	10.1	12.2	14.4	16.6	18.7	20.9	23.0	25.2	27.4	29.5	31.7	33.8	36.0	38.2	40.3	42.5	

## Pressure Loss

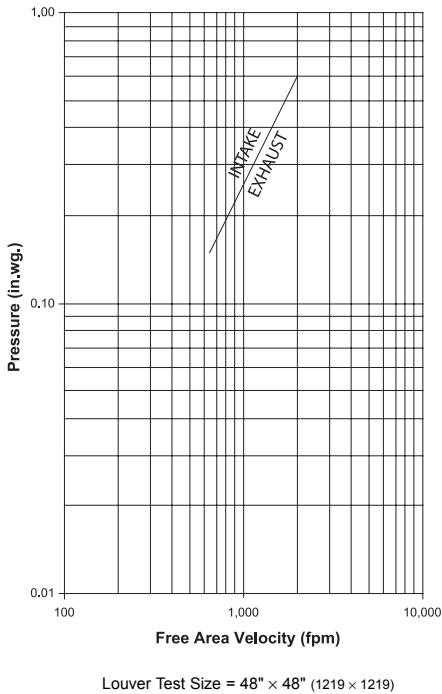

## Selection Criteria

Follow the steps listed below to calculate the louver size needed to satisfy the required air volume while minimizing the adverse effects of water penetration and pressure loss.

1. Determine the Free Area Velocity (FAV) at the maximum allowable pressure loss using the *Pressure Loss* chart to the left. While job conditions vary, typically, the maximum allowable pressure loss should not exceed 0.15 in.wg., and the FAV for 0.15 in.wg. pressure loss is listed on the front page of this sheet.
2. **Intake Applications** If the FAV at the Beginning Point of Water Penetration (shown below) is less than the FAV from step 1, then use the FAV at the Beginning Point of Water Penetration in step 3, otherwise use the FAV from step 1.
- Exhaust Applications** Use the FAV from step 1 in step 3.
3. Calculate the total louver square footage required using the following equation.

$$\frac{\text{Required Air Volume}}{\text{cfm}} \div \frac{\text{FAV}}{\text{fpm}} = \frac{\text{Required Louver (Free-Area) Size}}{\text{ft}^2}$$

4. Using the *Free Area* chart above, select a louver width and height that yields a free area ft<sup>2</sup> greater than or equal to the required louver size calculated in step 3.

## Water Penetration

Beginning Point of Water Penetration = 745 fpm

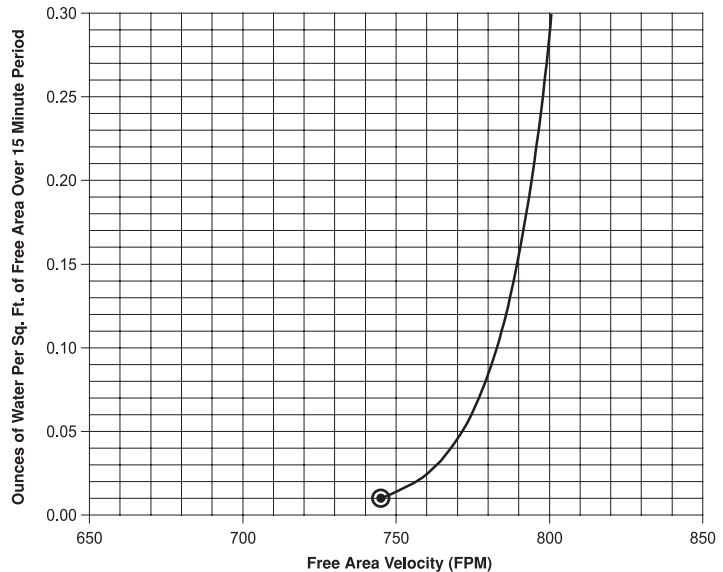

## Water Penetration

AMCA defines the beginning point of water penetration as the free area velocity at the intersection of a simple linear regression of test data and the line of 0.01 ounces of water per square foot of free area and is measured through a 48" x 48" louver during a 15 minute period. The AMCA water penetration test provides a method for comparing louver models and designs as to their efficiency in resisting the penetration of rainfall under specific lab conditions. ALL-LITE recommends that intake louvers are selected with a reasonable margin of safety below the beginning point of water penetration in order to avoid unwanted penetration during severe storm conditions.